

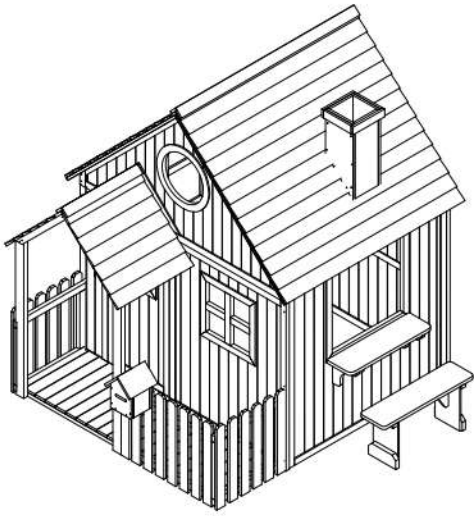











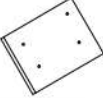

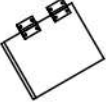

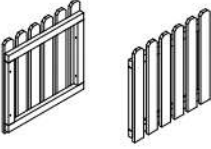







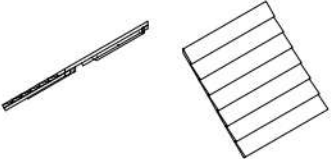







BULEN



OPOZORILO:
Izdelek mora biti dovolj
dobro zasidran v podlago
(odvisno od vrste podlage).
Nevarnost prevrnitve,
npr. zaradi močnega vetra.

1		1x	6		1x
2		1x	7		1x
3		1x	8		2x
4		1x	9		1x
5		2x	10		1x

11		1x	24		2x
12		1x	25		1x
13		2x	26		1x
14		1x	27		1x
15		2x	28		1x
16		1x	29		2x
17		2x	30		1x
18		1x	31		2x
19		2x	32		1x
20		1x	33		1x
21		1x	A	 6*90	2x
22		2x	B	 3.5*45	60x
23		2x	C	 3.5*35	22x
			D	 3.5*30	6x
			E	 3*30	24x
			F	 3*25	38x
			G	 3*20	2x
			H	 3*12	4x
			I	 >4*30	2x
			J		1x

1

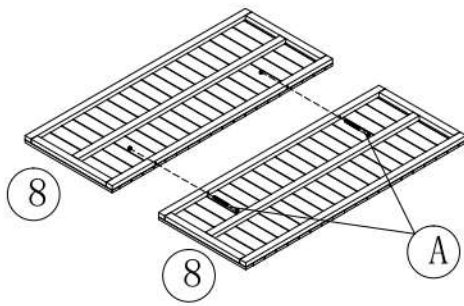

2

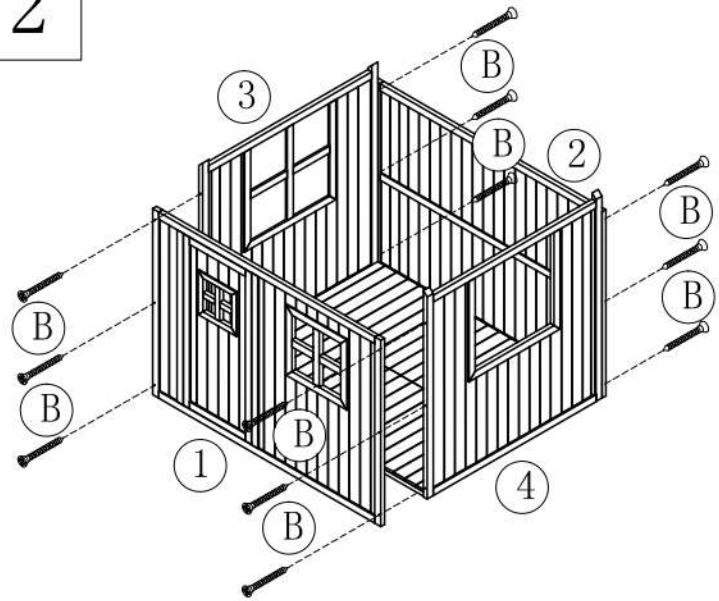

2

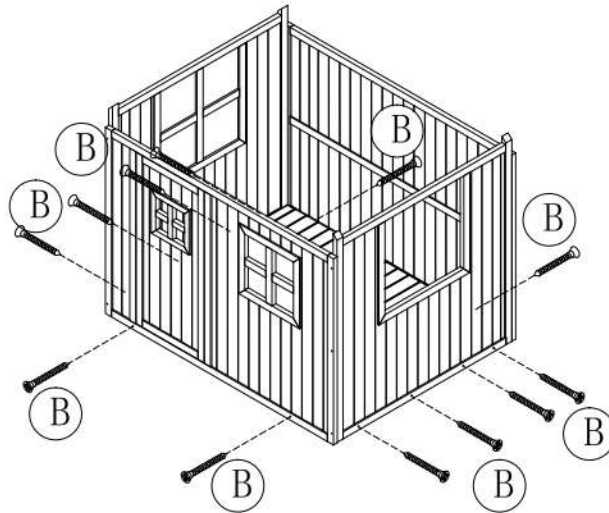

3

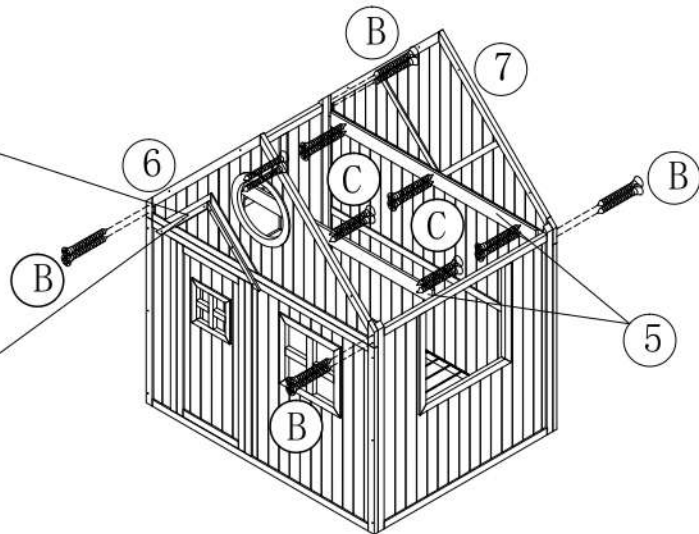
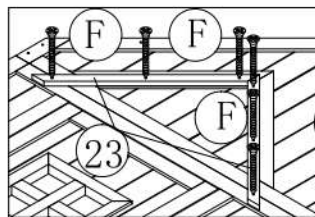
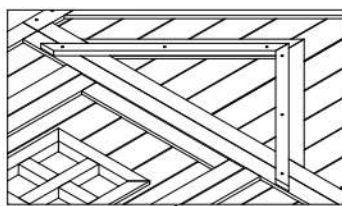

4

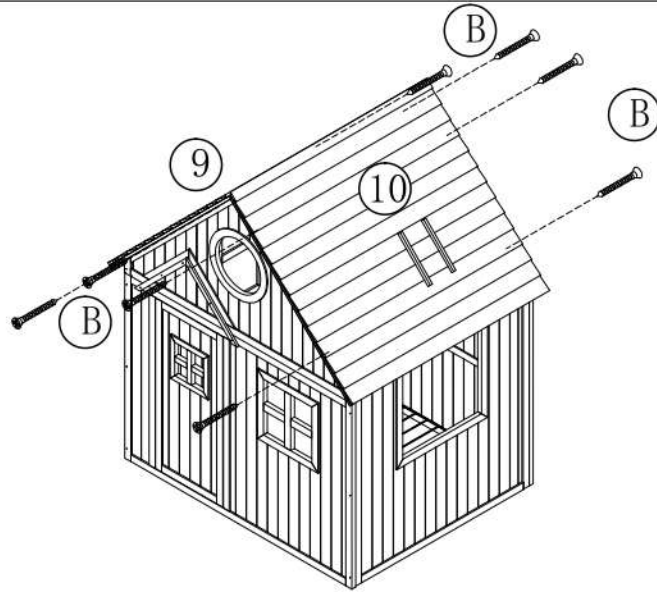

5

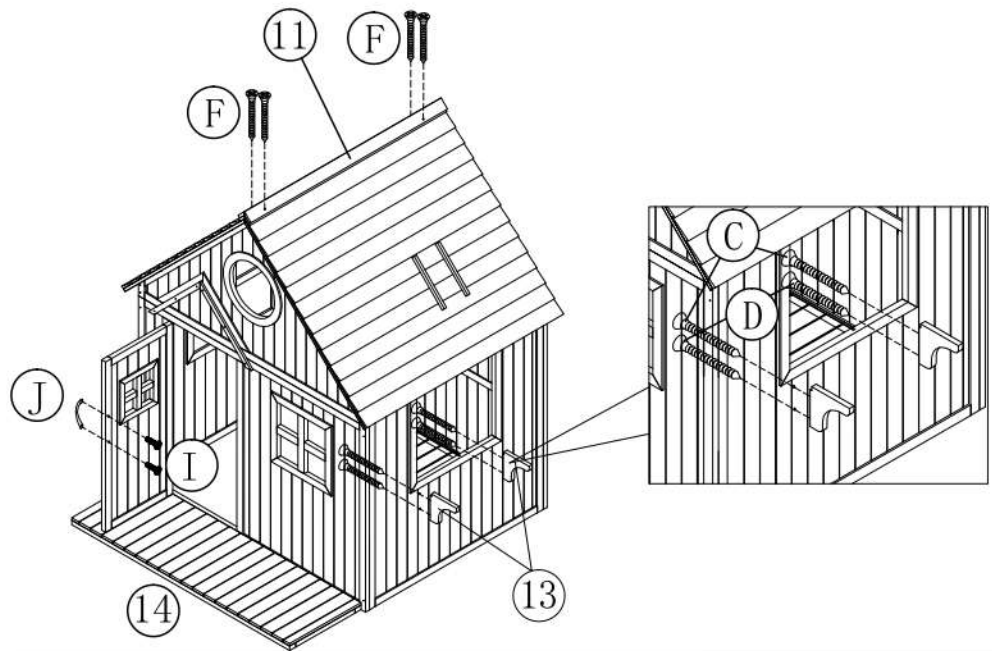

6

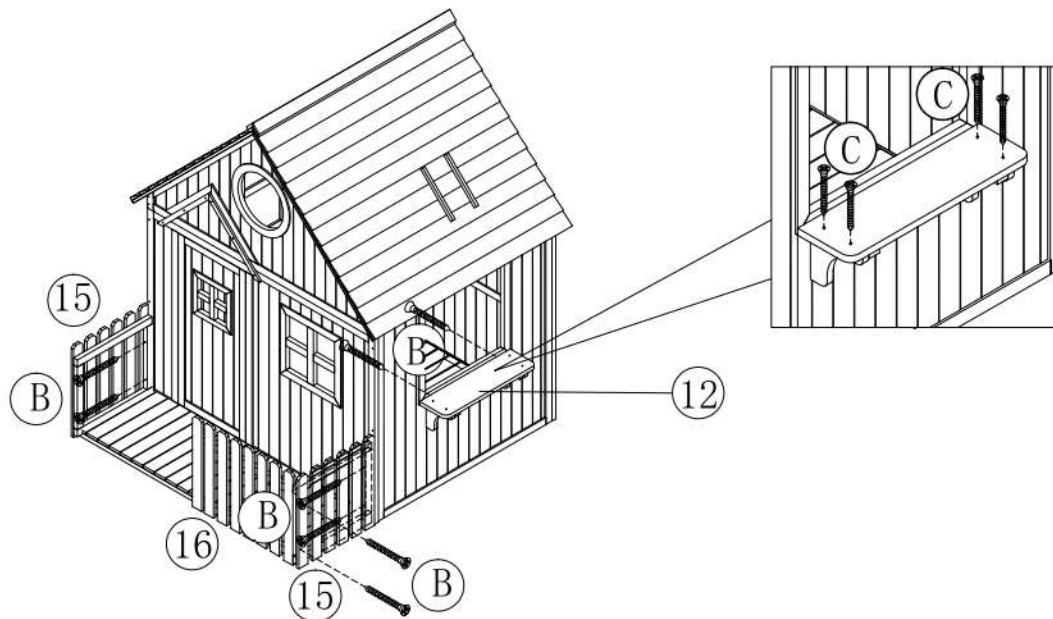

7

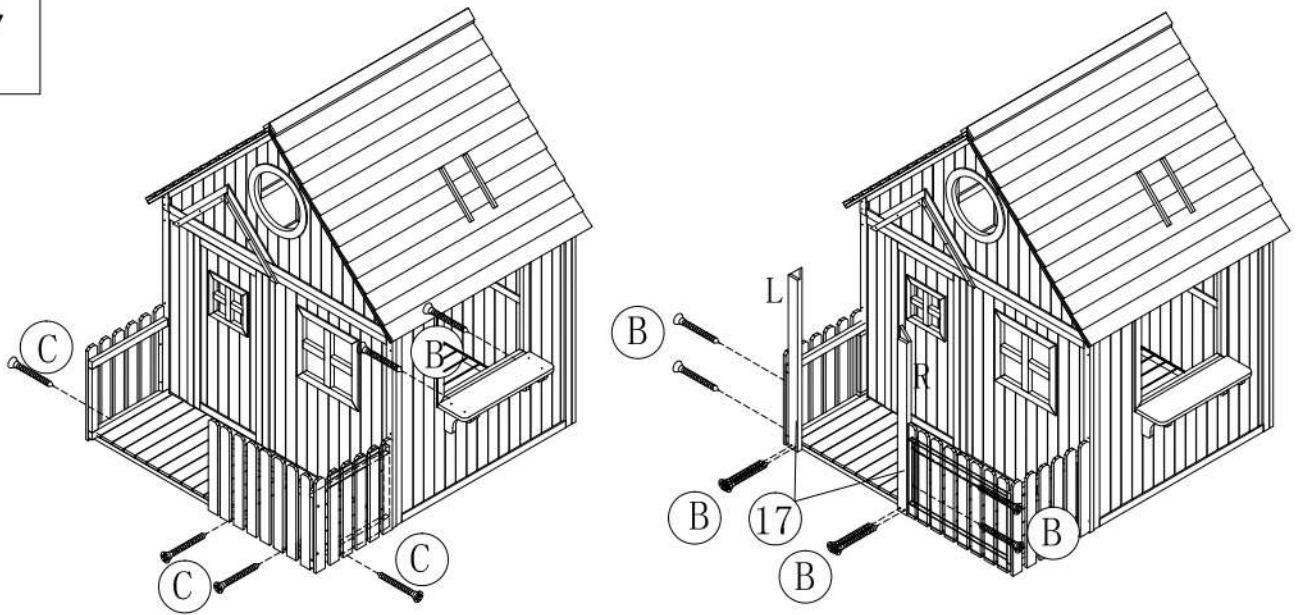

8

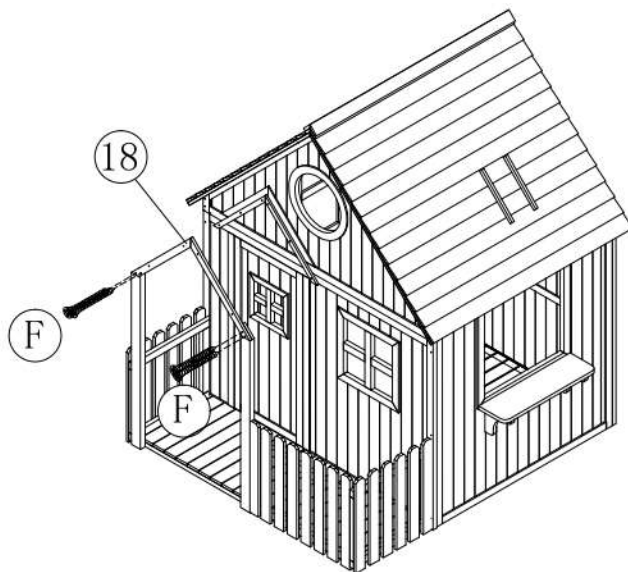

9

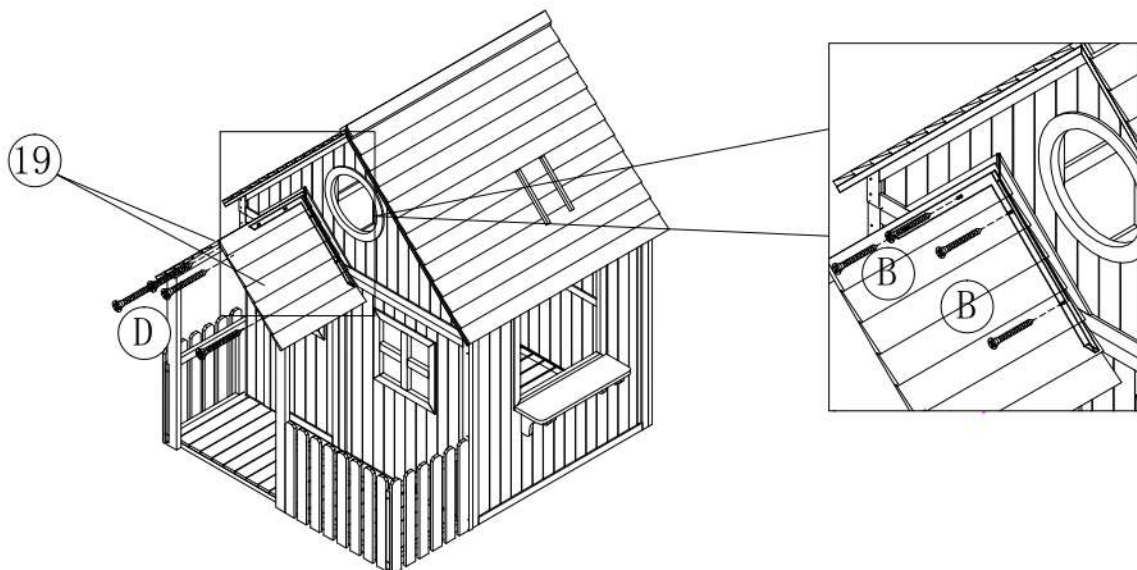

10

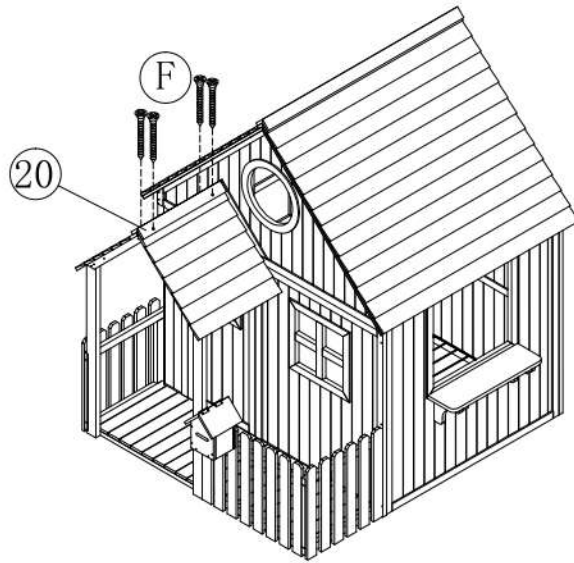

11

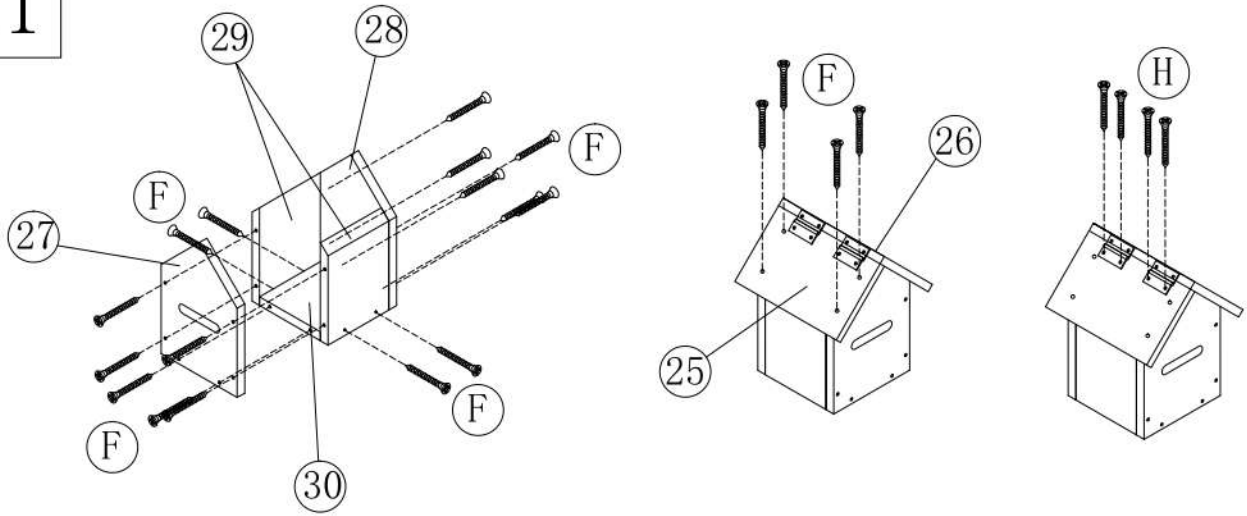

12

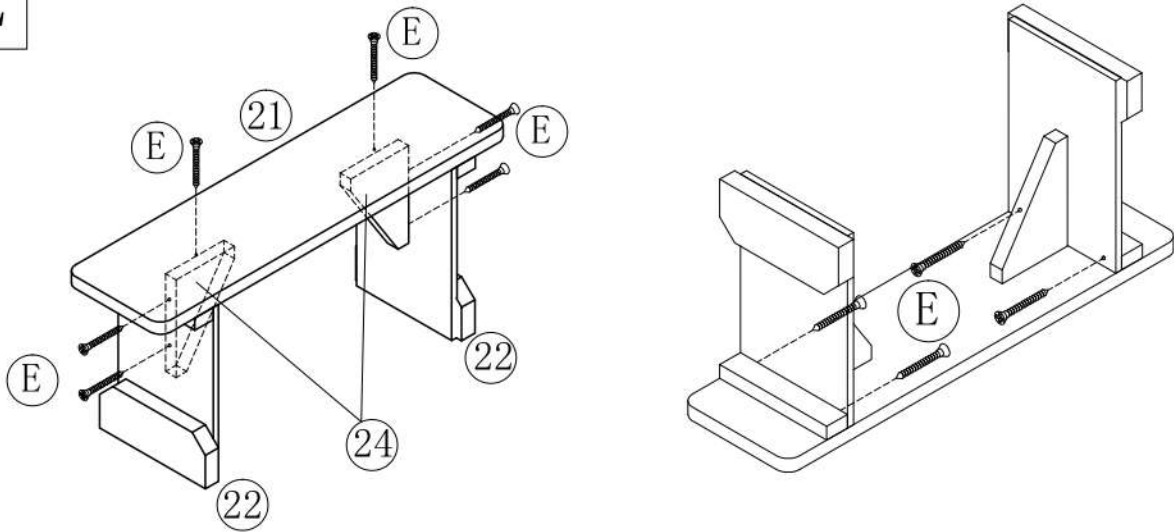

13

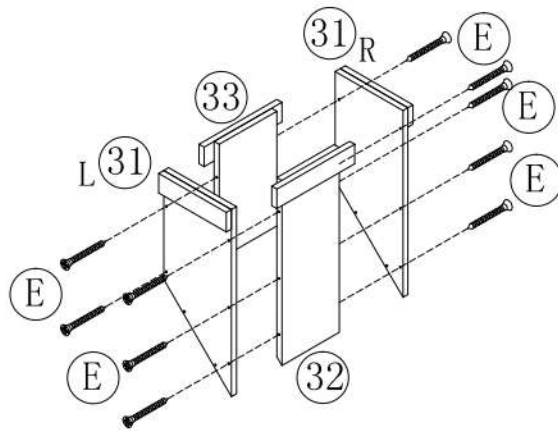

14

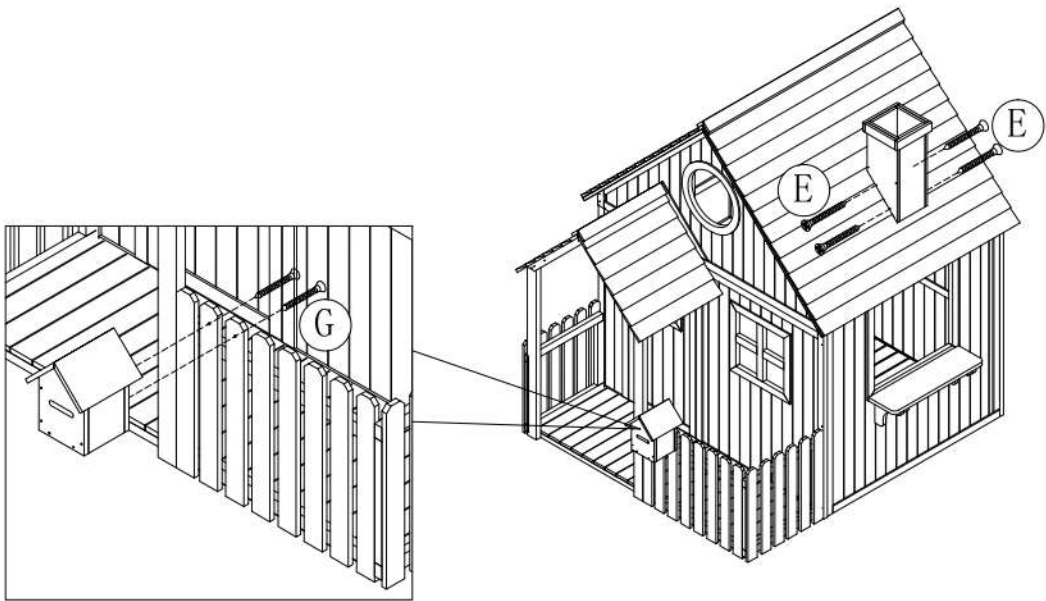

15

